

IMPORTANT

Pay close attention to the end of line DIP switch settings in the diagram and make sure you match them in the installation.

"1 ON and 1 OFF" (Twisted AWG 18)

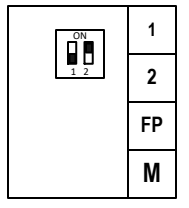

"Both ON" (Cat5/6)

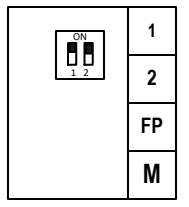

IMPORTANT

Pay close attention to the end of line jumper settings in the diagram and make sure you match them in the installation.

All in line 692D should have the T OUT jumper **"Removed"**.

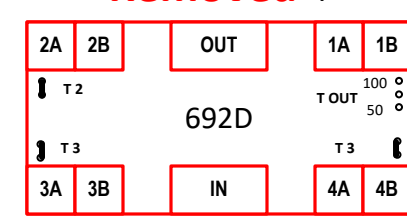

End of the riser 692D should have the T OUT Jumper in **"100" (Twisted AWG 18)** or **"50" (Cat5/6)**.

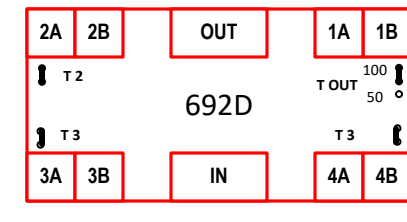

When an apartment station is connected to output 2, 3 and/or 4 **Remove Jumpers T2, T3, and/or T4**.

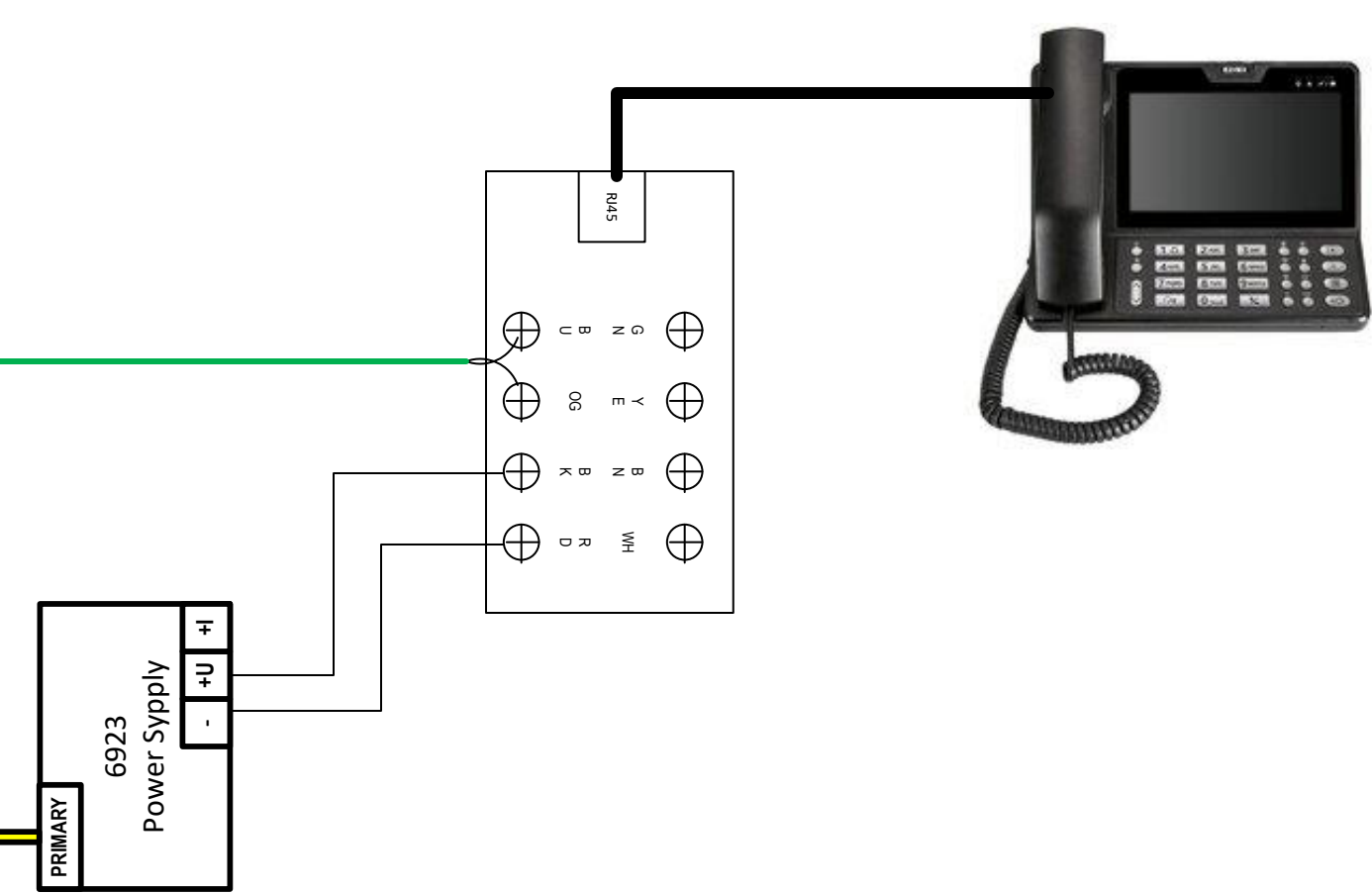
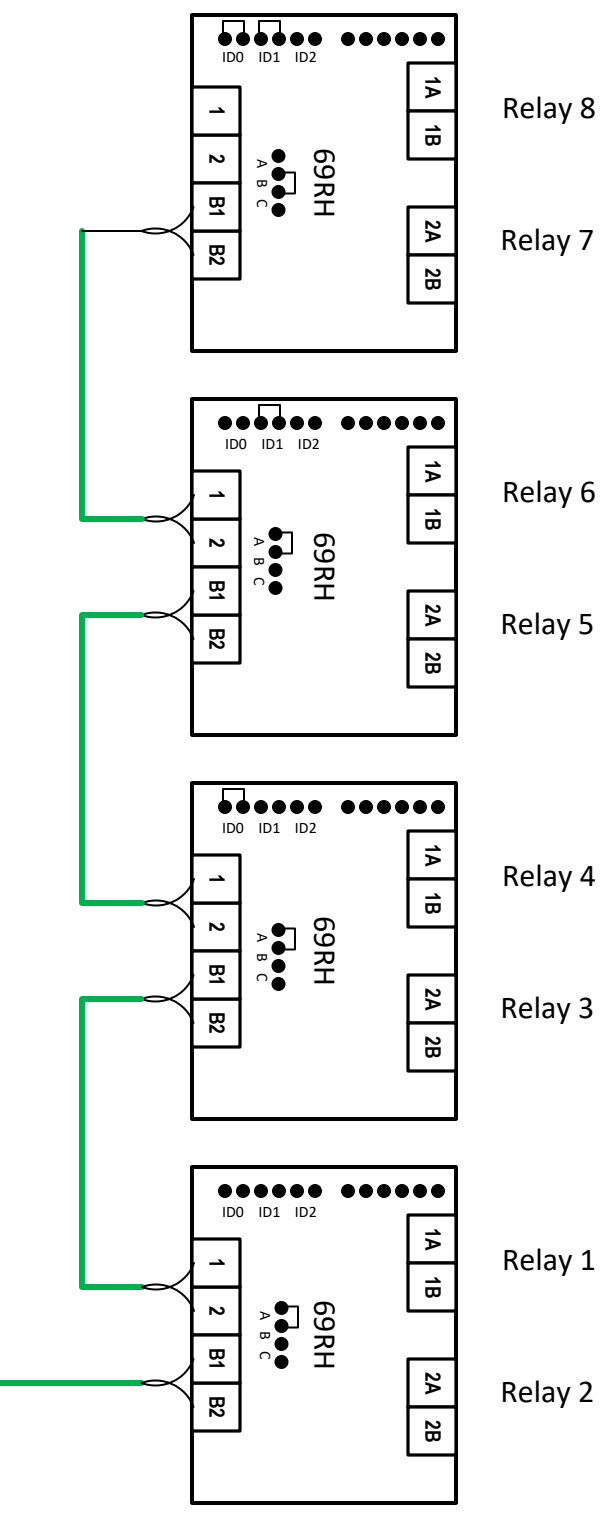
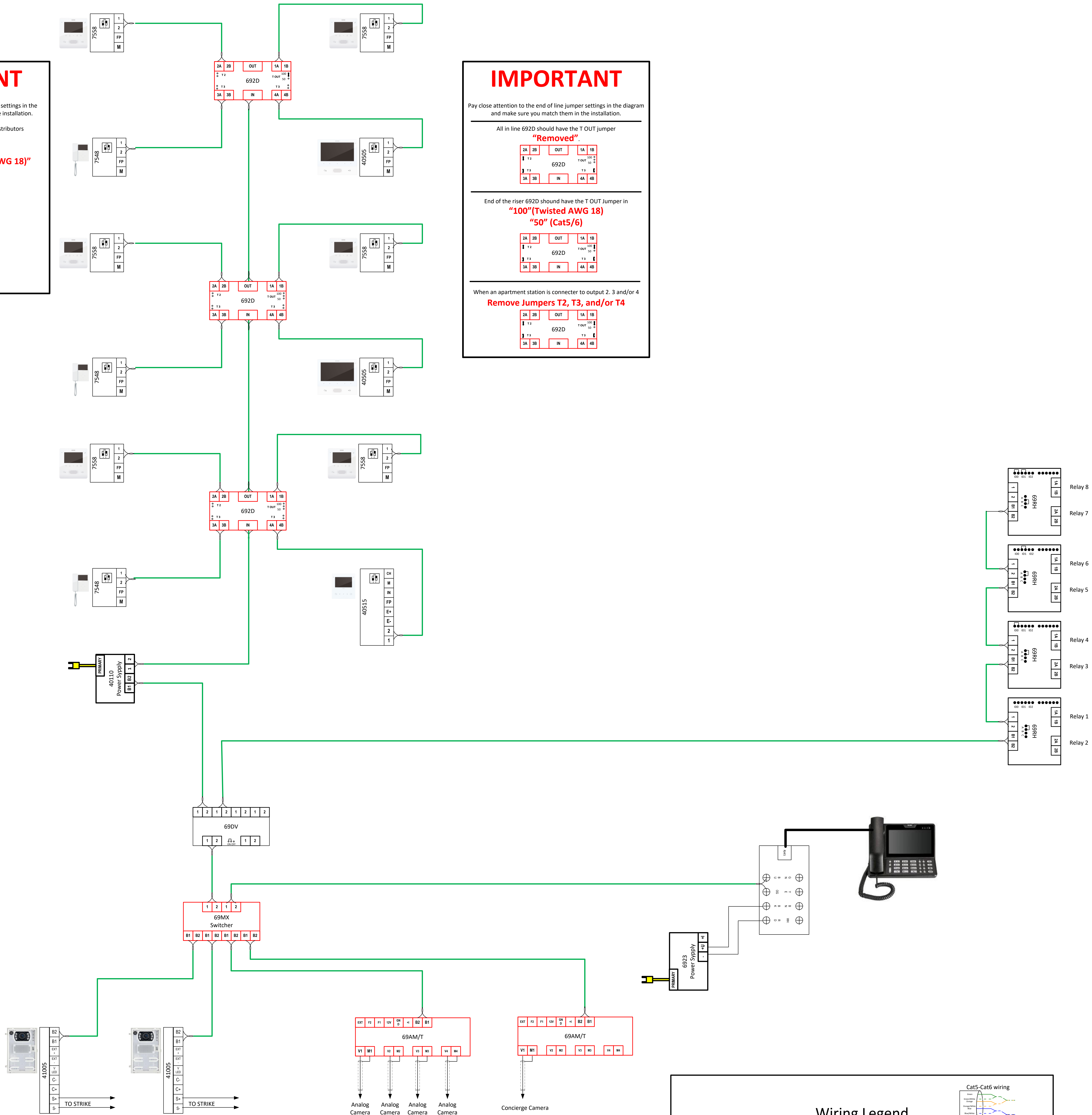
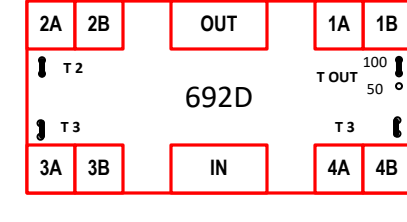

Wiring Legend

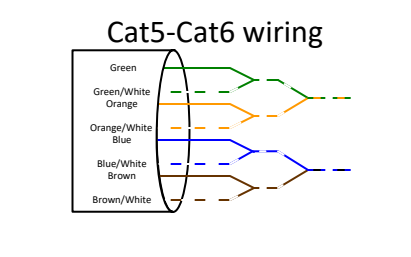
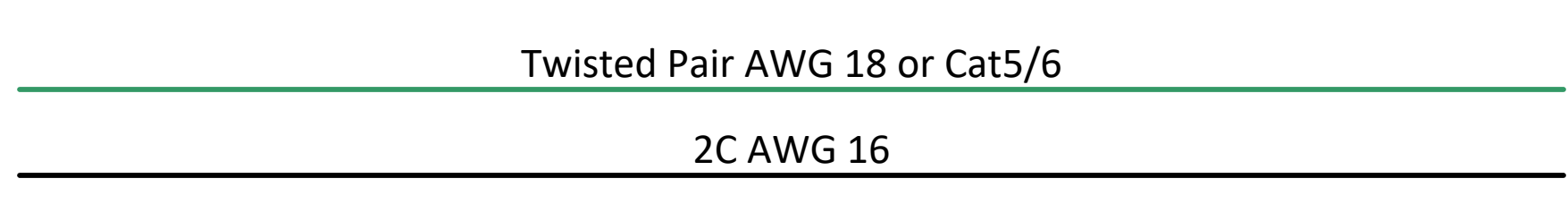

EDVEX DOOR ENTRY

Video 2 Entry - 1 Concierge 8 Relay 4 Aux Camera Central Riser system.vsd