

IMPORTANT

Pay close attention to the end of line DIP switch settings in the diagram and make sure you match them in the installation.

All monitors are home runs to the 692D Distributors
The Dip switches should be set to:

"1 ON and 1 OFF" (Twisted AWG 18)"

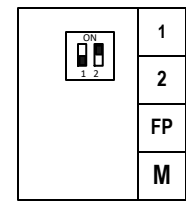

"Both ON" (Cat5/6)

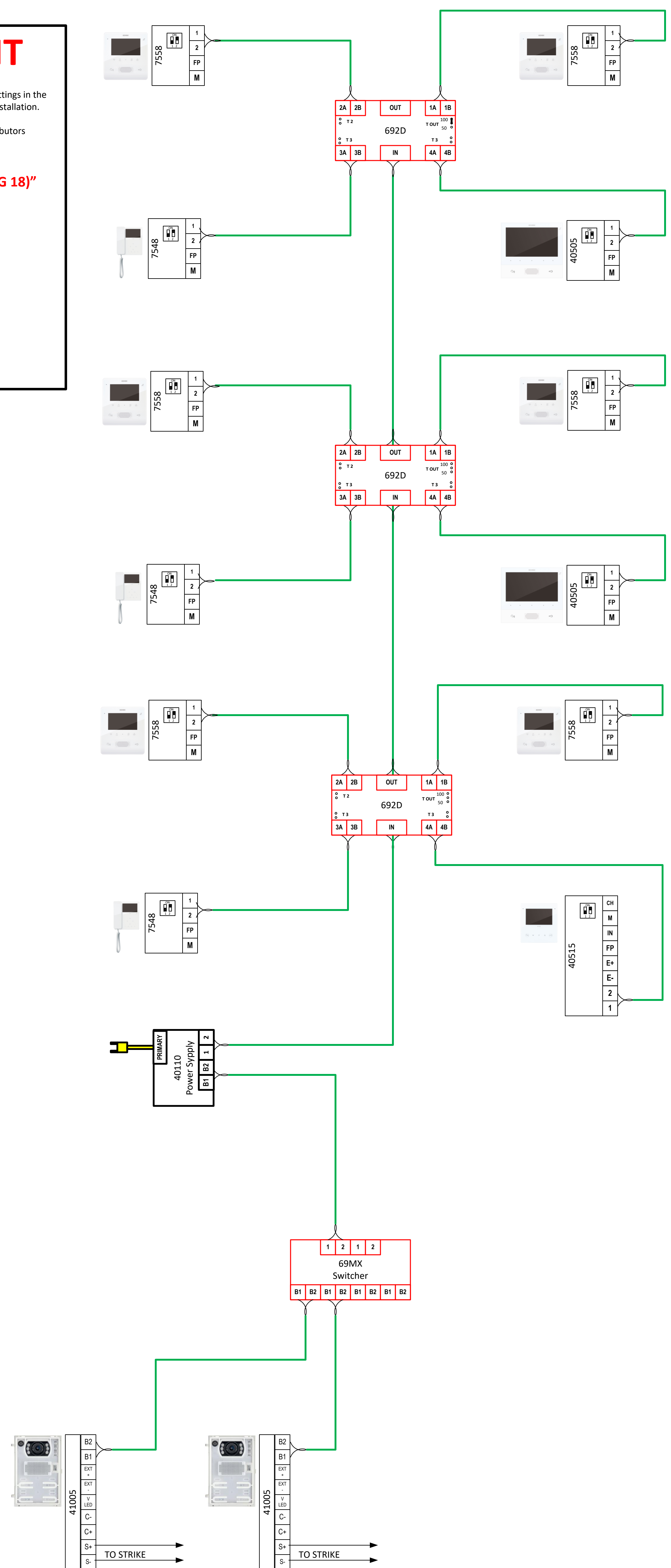
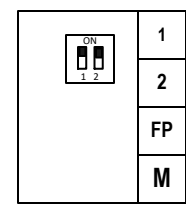

IMPORTANT

Pay close attention to the end of line jumper settings in the diagram and make sure you match them in the installation.

All in line 692D should have the T OUT jumper

"Removed"

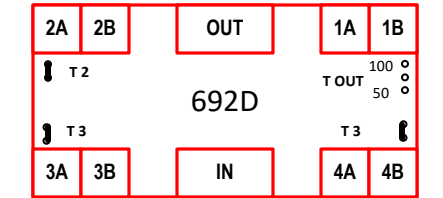

End of the riser 692D should have the T OUT Jumper in

"100" (Twisted AWG 18)

"50" (Cat5/6)

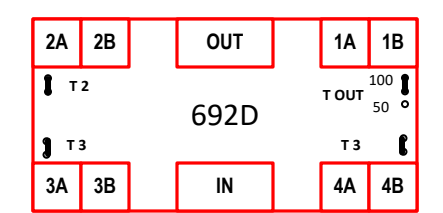

When an apartment station is connector to output 2, 3 and/or 4

Remove Jumpers T2, T3, and/or T4

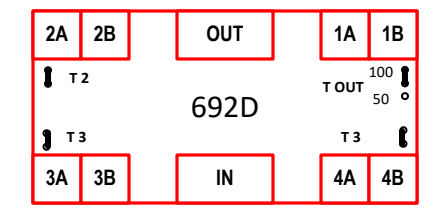

Wiring Legend

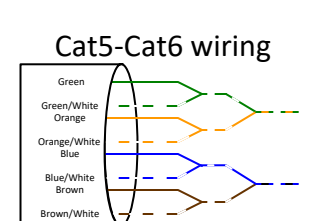

Twisted Pair AWG 18 or Cat5/6

2C AWG 16



EDVAX DOOR ENTRY

Video 2 Entry Central Riser system.vsd